





ASSEMBLY INSTRUCTION

A  Ø18x1.5mm X10	B  M6x16mm X04	C  M8x40mm X03	D  M8 X03	E  M5 X01	F  M8 X01
---	---	---	--	---	--

1

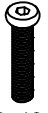
M8x18

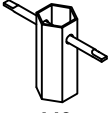
50%

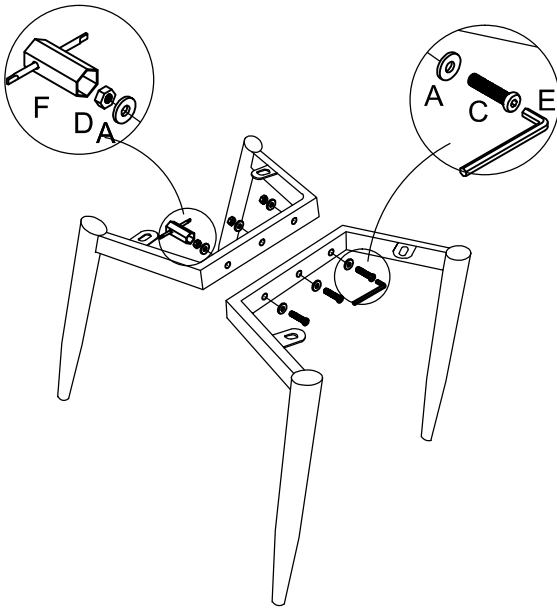

A C E
F D A

2

100%

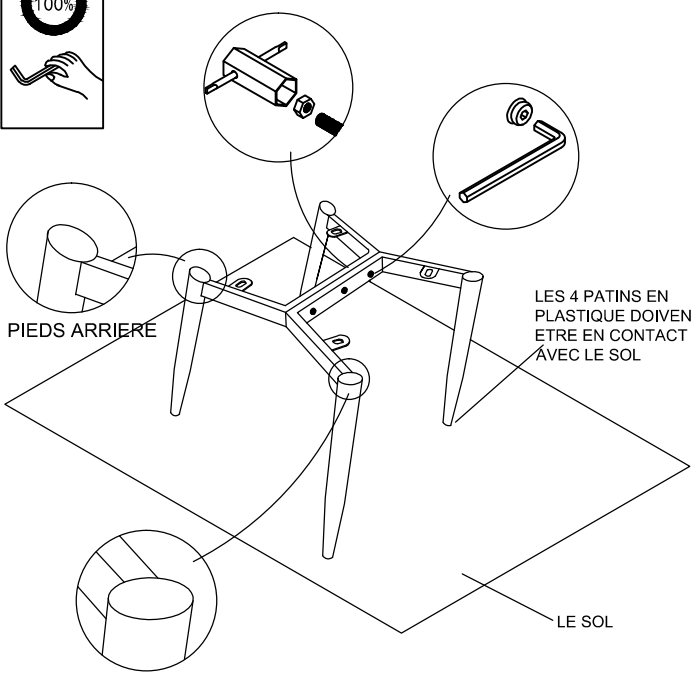

LES 4 PATINS EN PLASTIQUE DOIVENT ETRE EN CONTACT AVEC LE SOL

PIEDS ARRIERE

PIEDS AVANT

LE SOL

3

100%

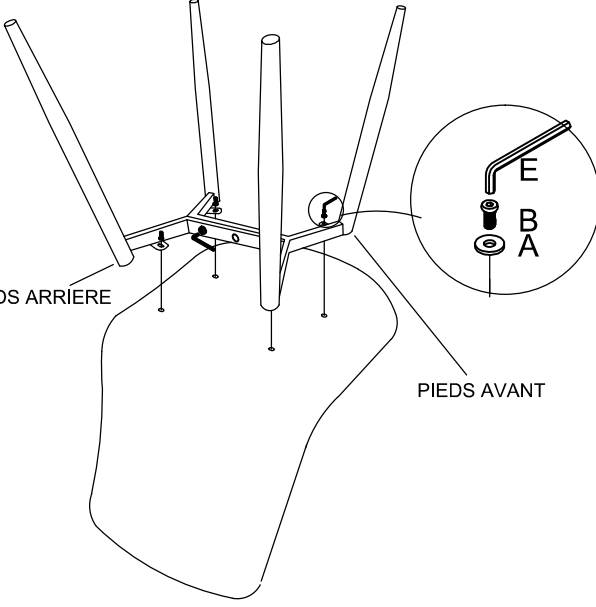

PIEDS ARRIERE

PIEDS AVANT

4

